



CM890i PRODUCT SPECIFICATIONS

System Type	8" coaxial, in-ceiling, high SPL, ported (66 W transformer for 25, 70.7, 100 V or transformer bypass)
Impedance (Nominal) ¹	8 Ω
Sensitivity dB @ 2.83 V / 1 M	93 dB
Sensitivity dB @ 1 W / 1 M ²	93 dB
Frequency Response (± 3 dB) ³	80 Hz - 22 kHz
Frequency Response (± 10 dB) ³	62 Hz - 22 kHz
Max. Program Power ⁴	250 W
Max. Continuous Power RMS ⁵	125 W
Max. Power SPL @ 1 M ⁶	114 dB
Coverage Angle (±6 dB @ 2 kHz)	115°
Coverage Angle (±6 dB @ 10 kHz)	80°
Coverage Angle (Averaged 2-10 kHz)	105°
Directivity Factor (Q)	4.4 (Avg. 100 Hz - 10 kHz) 5.5 (2 kHz)
Directivity Index (DI)	7.4 dB (Avg. 100 Hz - 10 kHz) 5.5 dB (2 kHz)
Tap Selector	Six-position rotary switch with transformer bypass position
Transducer: Low-Frequency Driver	203 mm (8") treated paper cone, cloth surround
Transducer: High-Frequency Driver	36 mm (1.42") titanium compression driver with waveguide
Low-Frequency Voice Coil	34 mm 1.34"
Crossover Frequency	2.2 kHz
Network Type: Low Pass	12 dB per octave, 2nd order
Network Type: High Pass	12 dB per octave, 2nd order
Enclosure Material	Drawn aluminum backcan with ABS baffle
Motor-board	Cast aluminum
Grille	Steel with powder-coat finish
Inputs	4-pin, 5.08 mm Euroblock for individual or daisy chain connection
Backcan Diameter	296.7 mm 11.7"
Backcan Height	201.7 mm 7.9"
Visible Diameter	374.9 mm 14.8"
Visible Height	27.4 mm 1.1"
Mounting Hole Diameter	323.9 mm 12.75"
Min. / Max. Ceiling Thickness	6.4 mm 0.25" - 48.5 mm 1.91"
Weight	6.5 kg 14.3 lbs
Included Accessories	Tile bridge, conduit plate, Euroblock connector, installation aid
Optional Accessories	Pre-construction bracket (AC-CM8-PCB), junction box (AC-CMi-JBOX)
Certifications	CE, RoHS, UL1480A, UL2043

Description

The CM890i is a premium 8", two-way, blind-mount in-ceiling, high-efficiency, high SPL loudspeaker for distributed or 8 Ω applications. The CM890i incorporates a dedicated 8" treated fiber driver and high-power compression transducer with a BroadBeamHP® waveguide to deliver a consistent dispersion pattern and superb intelligibility for the foreground music, sound reinforcement and PA markets.

The CM890i also incorporates a 66 W transformer with a six-position tap switch and transformer bypass position. Mounting hardware is included and features a fast and secure constant-tension, fixed-wing mounting system.

Features

- Patented BroadBeamHP® waveguide technology delivers a consistent BroadBeam dispersion pattern for maximum intelligibility and edge-to-edge coverage (2-8 kHz, independently verified)
- A 66 W transformer and high output (114 dB) for the sound reinforcement and PA markets
- One 8" (203 mm) treated fiber driver and one compression driver with a 1" (25.4 mm) exit mounted to a proprietary cast-aluminum baffle and heat sink
- Rapid installation blind-mount, fixed-wing mounting mechanism with constant-tension design affixing to ceiling thicknesses ranging from 0.25" (6.4 mm) to 1.91" (48.5 mm)
- Easy access six-position selectable tap switch for 25, 70.7, and 100 V applications with transformer bypass position
- Separate tool-free magnetic grille and bezel assembly with integrated safety cable for ease of install and in-field painting
- Average sensitivity of 93 dB offers high-output capabilities and reduced amplification costs
- UL1480A and UL2043 approved
- High-quality black or white paint finish. Custom paint colors optional
- Included accessories: tile bridge, Euroblock connector, conduit plate, and paint mask/ installation aid
- Optional accessories: color-coded (purple) pre-construction bracket (AC-CM8-PCB), and junction box (AC-CMi-JBOX)

¹ Impedance listed per IEC 60268-5 with a minimum less than 80% the nominal impedance

² 1 W/1 M sensitivity determined using nominal impedance

³ Frequency response measured in half or full space as dictated by speaker mounting configuration

⁴ Max program power is 3 dB above max continuous power

⁵ Continuous power rating, EIA-426-B test

⁶ Max output based on max continuous power

Transformer Taps

70.7 V	Output	100 V	Output	25 V	Output
66 W	111 dB	66 W	111 dB	5 W	100 dB
35 W	108.5 dB	35 W	108.5 dB	2.5 W	97 dB
19 W	106 dB	19 W	106 dB	1.25 W	94 dB
10 W	103 dB	10 W	103 dB	0.75 W	92 dB
5 W	100 dB				

Applications

Engineered for installations requiring full-range background/foreground music plus paging, the CM890i delivers a smooth and even coverage pattern. Ideal for casinos, convention centers, warehouses, nightclubs, gyms, aerobic rooms, airports, super stores, arenas, theme parks, transportation hubs, shipping centers, stadiums, and other high SPL or long-throw applications. For applications where additional bass is required, SoundTube's CM1001d-T subwoofer provides additional low-end response down to 41 Hz.

Patented Technologies

SoundTube Entertainment and the MSE Audio Group constantly develop new technologies which enhance audio product performance. SoundTube Entertainment innovations are protected by multiple U.S. and international patents, which explicitly cover SoundTube dome, enclosure and dispersion technologies. The MSE Audio Group actively defends its patents in order to protect SoundTube resellers and end-users.

BroadBeamHP® Wide Dispersion Technology

SoundTube's proprietary BroadBeamHP technology incorporates a high-frequency compression driver with a 1" exit mated to a treated fiber woofer. The BroadBeamHP technology delivers a consistent dispersion pattern across the upper registers of the frequency spectrum (2-8 kHz, independently verified). The result is an audio system requiring fewer speakers with higher intelligibility, offering reduced power needs, shorter installation time and cost savings on shipping and labor.

Technical Data and Specification Tools

SoundTube Entertainment strives to provide complete and effective technical information and data to dealers, engineers and designers. All data is available from SoundTube Entertainment or at www.soundtube.com.

Technical data and downloads include:

- EASE™ data - 3-D polar plots.
- EASE™ Address - 2-D modeling for distributed systems
- AutoDesk® Revit® software
- Tech Sheets - technical information and architectural specs for system engineers
- SoundTubeSPEC™ - Proprietary speaker placement software

Independent Data Acquisition and Verification

All data for SoundTube speakers is independently collected from and verified by NWAALabs (www.nwaalabs.com) using their proprietary MACH testing system. All data is collected and analyzed according to ASTM, ISO and AES standards using EASERA, TEF and MLSSA. Full balloon data including both phase and magnitude is compiled into a variety of formats including EASE 4.x, GLL and CLF.

Architectural Specifications

The loudspeaker shall consist of a 203 mm (8") low-frequency transducer and a high-frequency transducer with a 36 mm (1.42") titanium compression driver and a frequency dividing network installed in the ported enclosure. The low-frequency voice coil diameter shall be 34 mm (1.34").

Performance specifications of a typical production unit shall be as follows: Usable frequency response shall extend from 62 Hz - 22 kHz (± 10 dB, half space). Measured sensitivity (2.83 V, 1 M) shall be at least 93 dB. The speaker shall have a nominal impedance of 8 Ω . The speaker shall be available for 25, 70.7, and 100 V modes and shall include a six-position tap switch with a transformer bypass position. The frequency dividing network shall have a crossover frequency of 2.2 kHz with a slope of 12 dB per octave (2nd order). Rated power capacity shall be at least 125 watts continuous (RMS) and conform to EIA-426-B testing. Maximum continuous output at 1 meter shall be 114 dB.

The low-frequency transducer shall have a treated fiber cone and cloth surround.

Installation for the speaker shall be by two-screw, blind-mount, constant-tension winged assembly and shall attach to ceiling thicknesses ranging from 6.4 mm (0.25") to 48.5 mm (1.91"). A secondary attachment point has been included on the back of the unit. The external wiring input connector shall be a 4-pin, 5.08 mm Euroblock for 8 Ω or distributed systems and shall accept from 10 - 22-gauge wire.

The maximum backcan dimensions shall be no more than 201.7 mm (7.9") in height by 296.7 mm (11.7") in diameter. The maximum visible dimensions shall be no more than 27.5 mm (1.1") in height by 375 mm (14.76") in diameter. The backcan shall be constructed of aluminum.

The system shall include a 21-gauge painted steel support backing plate (tile bridge) to reinforce the ceiling material and tile support rails. The maximum tile bridge dimensions shall be no more than 600.1 mm (23.62") in length by 428.2 mm (16.86") in width and 10.4 mm (0.41") in height with a 325.1 mm (12.8") cutout for speaker mounting.

The grille shall be constructed of powder-coated steel with an ABS bezel. The affixed grille and bezel shall be mounted to the speaker enclosure (backcan) via magnetic attachment and included safety leash. Also included is a paint mask/installation aid for in-field painting (also serves as a hand-hold during mounting).

The unit has an optional color-coded (purple) pre-construction bracket (AC-CM8-PCB) that shall be compatible with an optional junction box (AC-CMi-JBOX). An 18-gauge wire whip and Euroblock connector shall be included with the junction box. The maximum dimensions of the pre-construction

bracket shall be no more than 635 mm (25") in length by 457.2 mm (18") in width and 127 mm (5") (includes affixed junction box) with a 326.1 mm (12.85") cutout for speaker mounting.

The system shall be the SoundTube CM890i for both low- and high-impedance applications.

SoundTube®

13720 W. 109th St.
 Lenexa, KS 66215
 Phone: 913.663.5600
 Fax: 913.663.3200
 Toll Free: 855.663.5600
 www.mseaudio.com

All SoundTube speakers come with a 5-year limited warranty and 3-year warranty on all electronics.

Graphs

Frequency Response

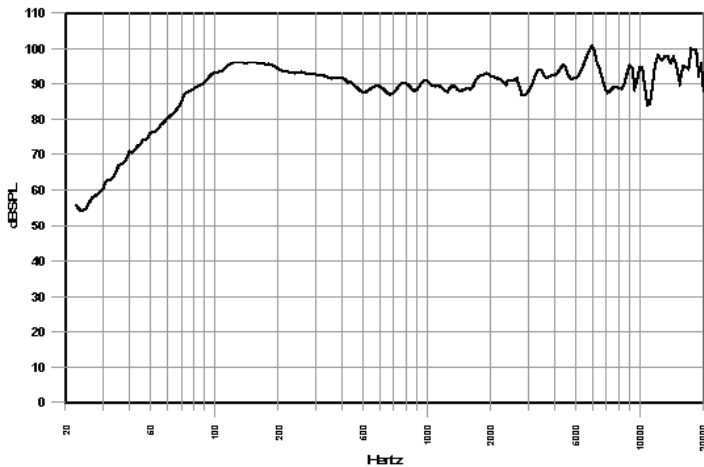

Phase/Impedance Response

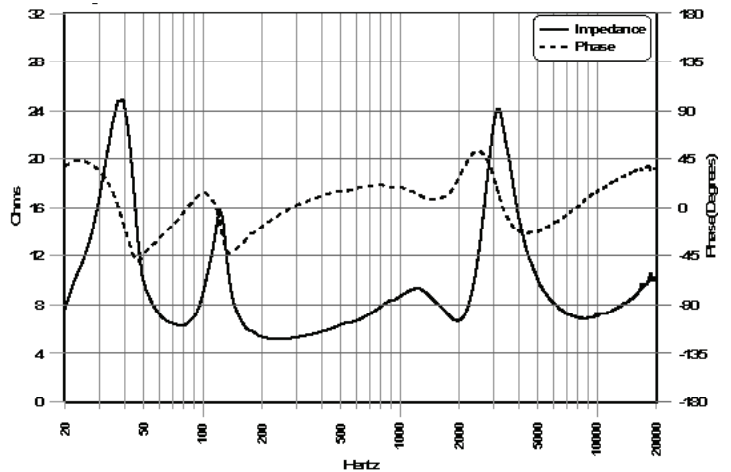

Vertical Beamwidth (±6 dB)

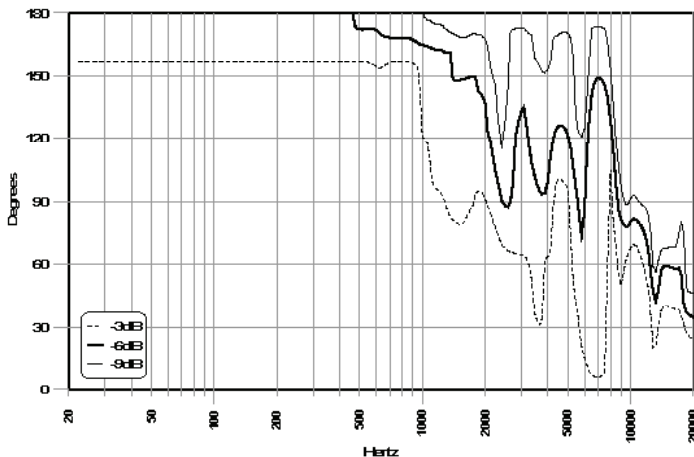

Directivity Index (DI)

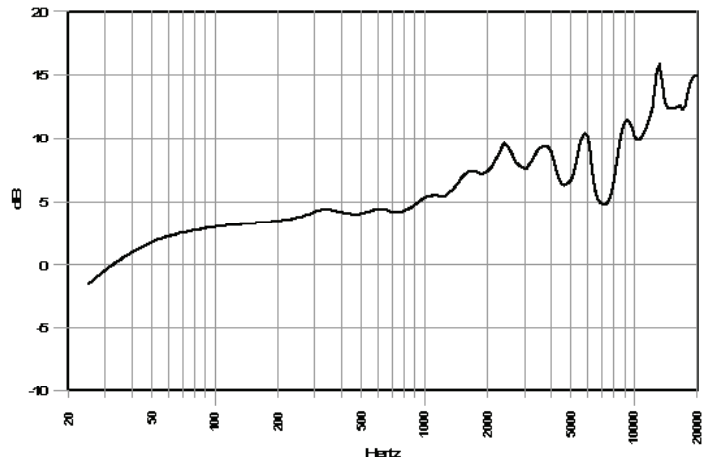

Mechanical Drawings

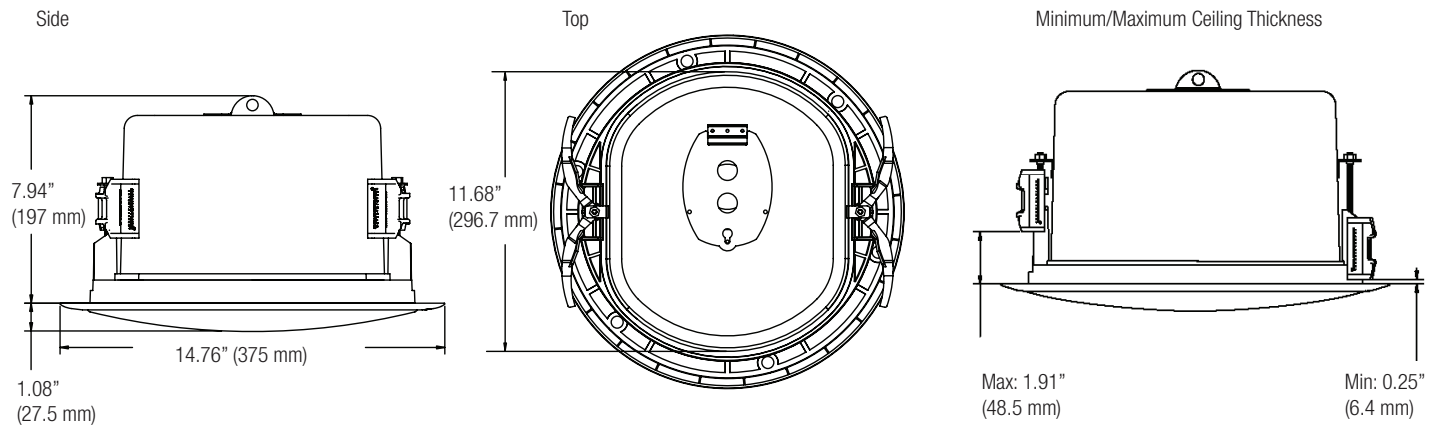

Optional Accessories

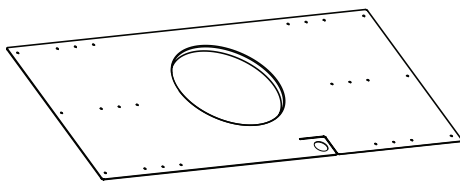

Pre-Construction Bracket
(AC-CM8-PCB)

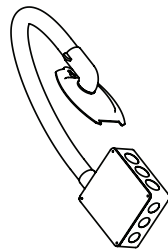

Junction Box
(AC-CMi-JBOX)

Included Accessories

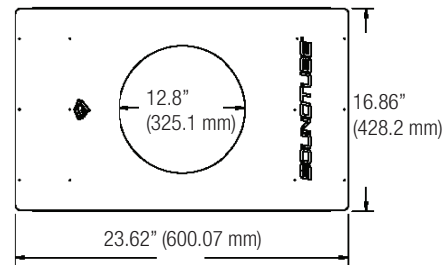

Tile Bridge

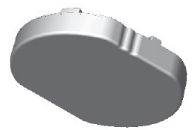

Paint Mask

Plots

